

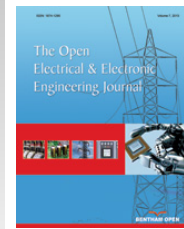

The Open Electrical & Electronic Engineering Journal

Content list available at: www.benthamopen.com/TOEEJ/

DOI: 10.2174/1874129001610010036



Modeling Research of Dielectric Permittivity Tensor in Unipole Cylindrical Plasma Antenna System Excited by Surface Wave

Jin Hongying*

Computer College of China West Normal University, Shida Road No. 1, ShunQing District, Nanchong, Sichuan, 637002, China

Received: August 9, 2015

Revised: September 22, 2015

Accepted: November 24, 2015

Abstract: The paper applies Boltzmann equation and gas molecular dynamics theory and analyzes the motion state of plasma internal particle and electromagnetic field distribution around antenna through modeling, It based on the cylindrical unipolar surface wave plasma antenna structure. Modeling calculation results of plasma antenna local dielectric tensor shows that the model method can reflect accurate dielectric relatively especially its each component of tensor changes. It is an exact method that calculate dielectric tensor of cylindrical surface wave excited plasma antenna.

Keywords: Cylindrical plasma antenna, Dielectric tensors, Modeling calculation, Surface wave.

1. INTRODUCTION

In the recent research of plasma antenna, the plasma is generally simplified as axial linear distribution of uniform distribution density cylindrical. Small power signals is transmitted in the form of surface wave propagation along the plasma column, and it has a small surface depth, this mode of the electromagnetic waves are similar to the metal unipolar antenna transmission modes [1 - 5].

Therefore Borg Harris Rayner [6, 7] simplified the high-density plasma antenna with the same similar electric and surface current distribution form with metal antenna.

However, the simplified solution above mentioned has many obvious limitations, first according to dual polarity effect, the plasma cylindrical radial density distribution is uneven, the resonance absorption also exists in antenna medium border surface and changes the wave space dispersion thus increases energy loss of wave. The inhomogeneity density of wave in radial direction makes the electromagnetic field distribution has no analytical solution forms, thus it should be used the numerical method to analyze. Papers [8 - 11] analyzes the cylindrical plasma electron density axial distribution, the related research when the plasma axial density dispersion is uneven, and the influence of the electromagnetic field distribution to the antenna parameters *etc.*

As for axial density is uneven dispersion (linear attenuation) in plasma column, there is no exact calculation and analysis of the approximate electric field each direction of axial distribution now. The uneven Axial dielectric tensor also can change the intensity of electromagnetic field in spatial variation. Therefore, a reasonable calculation method of dielectric tensor distribution is an important research content in the plasma antenna research work .

2. ANALYSIS OF MODELING THEORY

In unipole surface wave plasma antenna systems, small signal transmits in surface wave form in antenna surface, the antenna characteristics is determined by its internal state of plasma, its dielectric constant tensor is the important

* Address correspondence to this author at the Computer College of China West Normal University, Shida Road No. 1, ShunQing District, Nanchong, Sichuan, 637002, China; E-mail: jinhongying_cwnu@163.com

influence factor of antenna parameters performance. Due to the role of inductive magnetic field, the plasma antenna coefficient present the anisotropic and has the dielectric tensor.

The dependent relationship of dielectric tensor $\epsilon_{ij}(\omega, k)$ between frequency ω is the dispersion relationship, while electric tensor $\epsilon_{ij}(\omega, k)$ is in the dependence of the vector k , according to the space dispersion relationship.

Plasma antenna is belong to the weak cold magnetized plasma, so the DeBai shielding length λ_{DE} is very short, thus if don't take the influence of space dispersion into consideration. Dielectric tensor modeling is according to the electromagnetic field distribution characteristics from the axial and radial direction, the plasma antenna is divided into several dielectric tensor approximation of uniform distribution area, and then make the correlation analysis research and rational calculation.

2.1. Dielectric Tensor Calculation Model

In the one end of cylinder surface wave plasma antenna is the high-power RF coupling excitation source, the Rf power is coupled into antenna. Metal coil is approximately considered as a series of concentric circles, RF coil generated electromagnetic waves along the radial into plasma and electromagnetic waves along the coil has little changes. Unipolar incentive cylindrical plasma antenna experiment device is as the Fig. (1) shows.

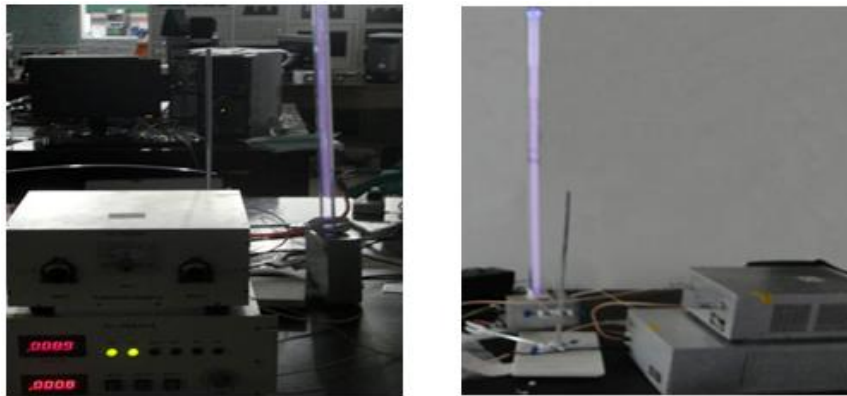

Fig. (1). The unipolar incentive column plasma antenna.

As the Figs. (2, 3) shows, in the antenna system the induction electric field is reverse symmetrical, the inductive magnetic field along is axial symmetry. When the plasma density is not very high, the inductive magnetic field and the induction electric field around the antenna is attenuation distribution.

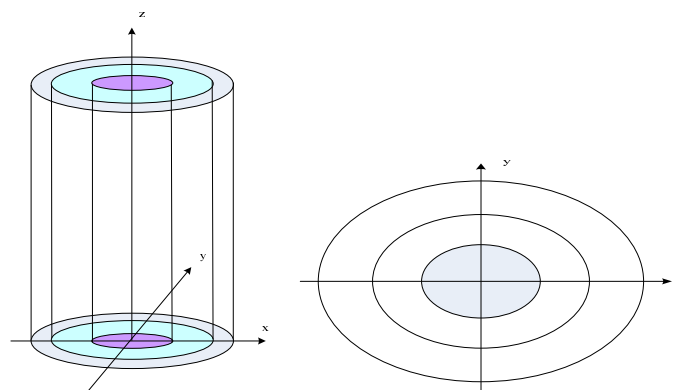

Fig. (2). The radial layered structure and projection schemes.

Cylindrical radial plasma antenna can be divided into many small cylindrical parts, as Fig. (2) shows, in each cylindrical plane the plasma inside can be regarded as evenly distributed. When the plasma density is high, the small power of transmitting signals on the plasma antenna has low surface depth. The plasma dielectric tensor distribution, according to its distribution along the plasma antenna, which then can be calculated by stratification subsection integral calculation model, just as Fig. (3) shows.

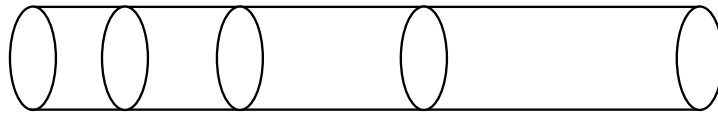

Fig. (3). The axial piecewise structure schematic drawing.

Assumptions for the Modle is as following:

1. Along the axial intercepted cylindrical plasma antenna unit length within the cylinder surface, the plasma antenna is divided into a series of concentric circles, projection of each circle the plasma is homogeneously distributed. Hence, reference to plasma radial distribution characteristics, the cylindrical plasma antenna along the axial can intercept multiple cylindrical surface, on each cylindrical inside plasma can be regared as evenly distributed.
2. Driving Rf power frequency is far outweigh the ion plasma oscillation frequency.
3. As the plasma density is high, the wall near the surface of scab cylindricald is very thin and is far less than the diameter of the antenna length, therefore sheath of the plasma can be neglected, at the same time the hot movement of electron is not considered in plasma.
4. In the border, electron is regared as come into the plasma from the area $|x > b$, so in the dynamic equation the area can be facilitated expanded to $|x| \rightarrow \infty$.
5. The time factor of physical quantities is $e^{j\omega t}$. So the Fourier series express of induction electric field is as follows:

$$E_f(x,t) = \sum_n E_n \sin(k_n x) e^{-j\omega t} \tag{1}$$

Where $k_n = n\pi / 2a$ is Fourier space wave sagittal number, through maxwell equation $\nabla \times E = -\partial B / \partial t$ then get:

$$\begin{cases} E_n = -E_{-n} \\ B_f(x,t) = -\frac{j}{\omega} \sum_n E_n \sin(k_n x) e^{-j\omega t} \end{cases} \tag{2}$$

Make the hypothesis that the inside small specific area of plasma antenna shows uniform distribution, the low-frequency magnetized plasma can be analyzed through molecular dynamics and relevant theorie, the dielectric tensor is composed of isotropic plasma dielectric constants, each component of it can be obtained through the corresponding formulas.

2.2. Analysis of Molecular Dynamics Theory

In the low temperature plasma antenna inductive magnetic field is weak, the molecule distribution function is close to isotropic distribution. Through dynamic model based on studying of the stationary processes and distribution characteristics of the electromagnetic wave with plasma, get the interaction between the relations, so as to deduce the external electric field, magnetic field changes conditions and plasma dielectric tensor distribution of mutual relationship.

The premise of dynamics theory research is, collision frequency is far below that of electric field frequency, so each collision of particle is in a relatively stable outside electric field. In the process of deducing the Boltzmann equation, assuming the collision time Δt is much smaller than $2\pi/\omega$ that of the cycle falternating field, so each collision occurs in a constant electric field, the pemise under the radio spectrum condition is satisfied, because molecular radius is about $10^{-8}cm$, the average speed of electron is largerer than $10^7cm/s$, the electron impact time is about $\Delta t < 10^{-15}s$.

Make the hypothesis that electronic speed distribution function is satisfied with the following Boltzmann equations as type (3):

$$\frac{\partial f}{\partial t} + v_x \frac{\partial f}{\partial x} - \frac{e}{m_e} (E_{rf} + V \times B_{dc}) \cdot \nabla_v f = S(f) \tag{3}$$

For low pressure high-frequency discharge, make the following hypothesis as type (4):

$$f = f_0 + f_1 \tag{4}$$

f_0 is the separately balance distribution and f_1 is the disturbance one, which is satisfied with the distribution $|f_1| \leq |f_0|$, put (4) type into (3) type get the following type (5):

$$\frac{\partial f_1}{\partial t} + v_x \frac{\partial f}{\partial x} - \frac{e}{m_e} (v \times B_{dc}) \cdot \nabla_v f_1 = \frac{e E_y(x)}{m_e} \frac{\partial f_0}{\partial v_y} - v f_1 \tag{5}$$

$$-\frac{e}{2m_e} \left[\left\langle E_y^* \cdot \frac{\partial f_1}{\partial v_y} \right\rangle + \left\langle E_y \cdot \frac{\partial f_1^*}{\partial v_y} \right\rangle \right] = \langle s(f_0) \rangle \tag{6}$$

Solving the disturbance, the speed distribution function f_1 , using cylindrical coordinates as $v_x = v_\perp \cos \phi$, $v_y = v_\perp \sin \phi$, $v_z = v_{||}$, v_\perp and $v_{||}$ are separately the vertical factor and parallel factor of magnetic field, the direction angel of speed space is $\phi = \tan^{-1}(v_y / v_x)$, so get the type (7):

$$\begin{aligned} & -\frac{e}{m_e} (v \times B_{dc}) \cdot \nabla_v f_1 \\ & = -\frac{e}{m_e} (v_y \frac{\partial}{\partial v_x} - v_x \frac{\partial}{\partial v_y}) f_1 \\ & = \omega_c \frac{\partial f_1}{\partial \phi} \end{aligned} \tag{7}$$

$\omega_c = eB/m_e$ is electron cyclotron rate. Make the assumption that $f_1^\pm = f_1(x, \pm v_x, t), v_x > 0$

Equation (2) can be written as the type (8):

$$\begin{cases} (v - i\omega) f_1^+ + v_x \frac{\partial f_1^+}{\partial x} + \omega_c \frac{\partial f_1^+}{\partial \phi} = \frac{e E_y}{m_e} \frac{\partial f_0}{\partial v_y} \\ (v - i\omega) f_1^- - v_x \frac{\partial f_1^-}{\partial x} - \omega_c \frac{\partial f_1^-}{\partial \phi} = \frac{e E_y}{m_e} \frac{\partial f_0}{\partial v_y} \end{cases} \tag{8}$$

$$\text{set } \begin{cases} F^+ = \frac{1}{2}(f_1^+ + f_1^-) \\ F^- = \frac{1}{2}(f_1^+ - f_1^-) \end{cases} \tag{9}$$

The equation (8) can be further written as type (10):

$$\begin{cases} (v - i\omega) F^+ + (v_x \frac{\partial}{\partial x} + \omega_c \frac{\partial}{\partial \phi}) F^- = \frac{e E_y}{m_e} \frac{\partial f_0}{\partial v_y} \\ (v - i\omega) F^- + (v_x \frac{\partial}{\partial x} + \omega_c \frac{\partial}{\partial \phi}) F^+ = 0 \end{cases} \tag{10}$$

Assuming in boundary region electron happening “mirror” reflect, so get the following type (11):

$$\begin{cases} F^+(x, \vec{v}) = \sum_{n=-\infty}^{\infty} F_n^+ \sin(k_n x) \\ F^-(x, \vec{v}) = \sum_{n=-\infty}^{\infty} F_n^+ \cos(k_n x) \\ E_y(x) = \sum_{n=-\infty}^{\infty} E_n \sin(k_n x) \end{cases} \tag{11}$$

After a series deducing get the disturbance distribution function is as type (12).

$$f_1(x, v, t) = -\frac{i(v - i\omega)e}{m_e} \frac{\partial f_0(v)}{\partial v_\perp} \left[\sum_{n=-\infty}^{\infty} \sum_{l=-\infty}^{\infty} \sum_{m=-\infty}^{\infty} \frac{E_n \sin(k_n x) J_m(k_n \rho_\perp) J'_l(k_n \rho_\perp) e^{i(m-l)\phi - i\omega t}}{m^2 \omega_c^2 + (v - i\omega)^2} \right] \tag{12}$$

$\rho_\perp = v_\perp / \omega_c$ is electron cyclotron radius, $J_m(x)$ is the first kind Bessel function, $J'_m(x)$ is symbol of $d[J_m(x)] / dx$, m, l is integer. After getting disturbance distribution function, put it into (6) and (7) type then get the following differential equations is as type (13):

$$-\frac{d}{d\varepsilon} \left[(D_B + D_{ee}) \frac{df_0(\varepsilon)}{d\varepsilon} \right] - \frac{d}{d\varepsilon} \left[(v_{el} + v_{ee}) f_0(\varepsilon) \right] = \sum_k \left[\sqrt{\varepsilon + \varepsilon_k^*} v_k^* (\varepsilon + \varepsilon^*) f_0(\varepsilon + \varepsilon^*) - \sqrt{\varepsilon} v_k^* (\varepsilon) f_0(\varepsilon) \right] \tag{13}$$

Among them, $D_B(\varepsilon) = \frac{e^2 \varepsilon^{3/2}}{m_e \omega} \sum_n |E_n|^2 \phi_B(n, \varepsilon)$ $\phi_B(n, \varepsilon) = \sum_{m=-\infty}^{\infty} \int_0^\pi \left[\frac{\beta J_m^2[\lambda_n(\varepsilon) \sin \theta] \sin^3 \theta}{\beta^2 + (m\alpha - 1)^2} \right] d\theta$

So the conductivity in Fourier space can be expressed is as type (14):

$$\sigma_n^B = \frac{n_0 e^2}{2m_e \omega_0} \int \varepsilon^{3/2} \frac{\partial f_0(\varepsilon)}{\partial \varepsilon} [\phi_B(n, \varepsilon) + i\nu_B(n, \varepsilon)] d\varepsilon \tag{14}$$

So electronic and electromagnetic interaction function is as the following type:

$$\psi_B(n, \varepsilon) = \sum_{m=-\infty}^{\infty} \int_0^\pi \left[\frac{(m\beta - 1) J_m^2[\lambda_n(\varepsilon) \sin \theta] \sin^3 \theta}{\beta J_m^2[\lambda_n(\varepsilon) \sin \theta] \sin^3 \theta} \frac{\alpha^2 + (m\beta - 1)^2}{\alpha^2 + (m\beta - 1)^2} \right] d\theta \tag{15}$$

For specific distribution area, plasma distribution is approximate uniform, such as the time and the spatial change of external incentives electric field, current and conductivity can be written as (16) and (17) type, which is calculated by a particular space within the dielectric tensor.

$$j(x, t) = \int_{-\infty}^t dt' \int dr' \sigma_n^B(x, x'; t, t') E(x', t') \tag{16}$$

$$\sigma_n^B(k, \omega) = \int_0^t dt \int dt' \sigma(x, t) e^{j(\omega t - k \cdot x)} \tag{17}$$

$$\varepsilon_{i,j}(k, \omega) = I + \frac{\sigma(k, \omega)}{j\omega \varepsilon_0} \tag{18}$$

Among them, $\|I\|$ is the three ranks unit matrix

$$\| \sigma(k, \omega) \| = \begin{bmatrix} \frac{\varepsilon_0 \omega_p^2 (j\omega + v_c)}{\omega_b^2 + (j\omega + v_c)^2} & -\frac{\varepsilon_0 \omega_p^2 \omega_b}{\omega_b^2 + (j\omega + v_c)^2} & 0 \\ \frac{\varepsilon_0 \omega_p^2 \omega_b}{\omega_b^2 + (j\omega + v_c)^2} & \frac{\varepsilon_0 \omega_p^2 (j\omega + v_c)}{\omega_b^2 + (j\omega + v_c)^2} & 0 \\ 0 & 0 & \frac{\varepsilon_0 \omega_p^2}{(j\omega + v_c)} \end{bmatrix} \tag{19}$$

ω_b is electron cyclotron frequency, ω_p is plasma angle, ν_c is collision frequency, ω is the frequency of signal source. For convenience, the dielectric tensor type (19) can be written as the type (20):

$$\vec{\varepsilon} = \begin{bmatrix} \hat{S} & -i\hat{D} & 0 \\ i\hat{D} & \hat{S} & 0 \\ 0 & 0 & \hat{P} \end{bmatrix} \tag{20}$$

$$\hat{S} = 1 + \frac{i\omega_p^2(j\omega + \nu_c)}{\omega[\omega_b^2 + (j\omega + \nu_c)^2]}, \hat{D} = -\frac{\omega_p^2\omega_b}{\omega[\omega_b^2 + (j\omega + \nu_c)^2]},$$

$$\hat{P} = 1 + \frac{\omega_p^2}{j\omega(j\omega + \nu_c)}$$

3. NUMERICAL CALCULATION PROCESS OF MODEL

Under the initial condition, according to external electromagnetic field distribution, the plasma length, signal frequency, plasma radius, the amplitude of the antenna surface current, the plasma density of the unit length of the antenna is known. When plasma dielectric tensor changes, the electromagnetic wave propagation will caused the change of working frequency, direction graph characteristics of antenna *etc.* The calculation method process is as follows:

From the initial condition plasma density n_0 and pressure p , assuming the electronic energy distribution function is $f_0(\varepsilon)$, the first step is to solve electromagnetic equations to get E_n , then get the energy diffusion coefficient D_E , and through solving the electronic dynamic equation get the new distribution functions $f_0(\varepsilon)$. The second step is to judge whether the $f_0(\varepsilon)$ is convergence, if not, the calculation is continued to get a new E_n , until a stable outcome, the last step is a series of derivation $f_0(\varepsilon)$, and get the spatial distribution of electromagnetic field. After getting the plasma density (plasma frequency), plasma collision frequency, internal and external radius, then the plasma antenna dielectric tensor can be calculated. The finite difference method can be expressed as type (13), the type can be simplified as the type (21):

$$\frac{d}{d\varepsilon} \left[p \frac{df^k}{d\varepsilon} \right] + \frac{d}{d\varepsilon} (Qf^k) - Rf^k = -D \tag{21}$$

$p = p(\varepsilon, f^{k-1})$, $Q = Q(\varepsilon, f^{k-1})$, $D = D(\varepsilon, f^{k-1})$, $R = R(\varepsilon)$, k is the number of alternate, put energy ε into E_ε split, the interval is H .

So, on the first grid points $i = 1, \dots, N_\varepsilon$ the energy is expressed as type (22):

$$\varepsilon_i = (i - 1)h \tag{22}$$

Then its abbreviations and differential form can be expressed the type (23):

$$f_i^k = f^k(\varepsilon_i), p_i = p(\varepsilon_i), Q_i = Q(\varepsilon_i), R_i = R(\varepsilon_i), D_i = D(\varepsilon_i)$$

$$\frac{d}{d\varepsilon} \left[p \frac{df^k}{d\varepsilon} \right] = \frac{1}{h^2} [p_{i+1/2}(f_{i+1}^k - f_i^k) - p_{i-1/2}(f_i^k - f_{i-1}^k)]$$

$$\frac{d}{d\varepsilon} (Qf^k) = \frac{1}{2h} (Q_{i+1}f_{i+1}^k - Q_{i-1}f_{i-1}^k)$$
(23)

The number of linear equations is N_ϵ :

$$(hQ_{i-1} - 2p_{i-1/2})f_{i-1}^k + [2(p_{i+1/2} - p_{i-1/2}) + 2h^2R_i]f_i^k - (hQ_{i+1} + 2p_{i+1/2})f_{i+1}^k = 2h^2D_i \quad i = 1, \dots, N_\epsilon + 1 \tag{24}$$

Equations (24) is a coefficient diagonal matrix, it can be solved though diagonal matrix and the process is iterative, when it get satisfied convergence outcome, the iterative process is end. The iteration process normalization conditions must be satisfied with the type (25) below:

$$\sum_i f_i \epsilon_i^{1/2} h = 1. \tag{25}$$

After getting the expression of f_0 , available space distribution and power distribution of the electromagnetic energy, then the distribution of antenna dielectric tensor can be worked out.

Figs. (4, 5) show the electromagnetic field spatial distribution of the simple self-consistent model and linear model along the antenna, the figure show that, outcome of linear model present exponential attenuation, and with the increase of electric current, only with intensity corresponding increase, and space distribution of shape has not changed. The self-consistent model presents some abnormal behavior, with discharging coil distance increases, electric field reduces to a minimum attenuation, then increases slowly to a larger value again after its decreasing, especially along with the increase of electric current, the abnormal behavior is increasingly clear.

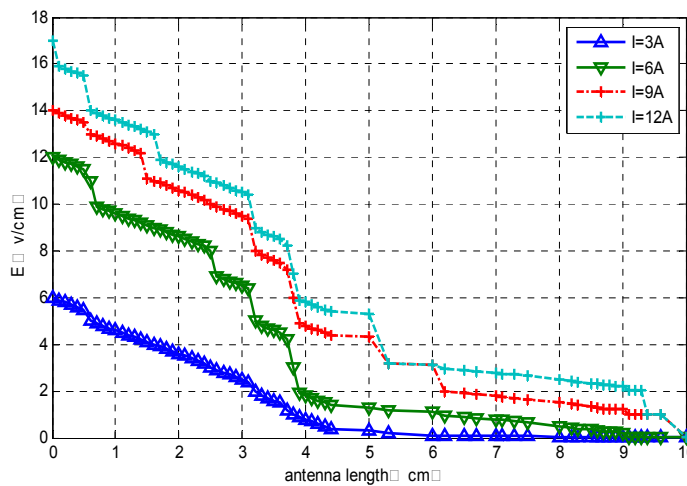

Fig. (4). The electric maxwell's distribution.

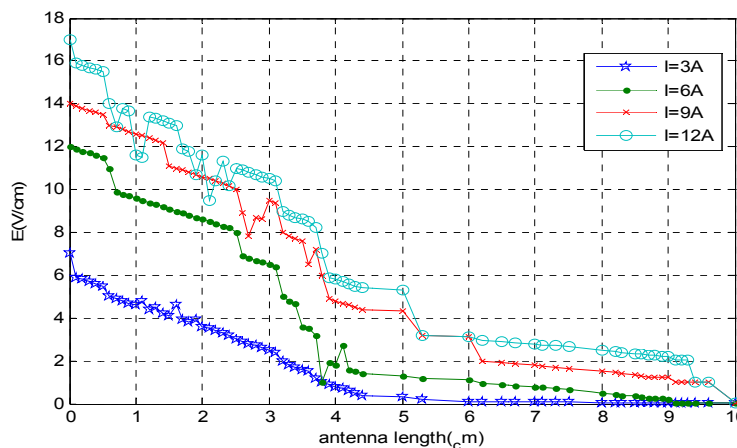

Fig. (5). The model the distribution of electric field.

The reasons is in low pressure plasma, electron gains energy inner electric field nearfrom the coil, under the force $v \times B_{rf}$, electron is in radial motion, when the electronic speed and electromagnetic wave speed is approximate the same, there happens Rang-Dao hinder phenomenon, which causes the electric abnormal behavior. Experimental tests also shows the abnormal behavior of electric field mentioned above, so dynamics model can more accurately reflect the plasma antenna electric field around, while ordinary model cannot reflect the situation.

Figs. (6-8) are the dielectric tensor curves get from the plasma antenna model. When the temperature of plasma is not too high, the plasma antenna dielectric tensor distribution is relatively smooth, but in some part of the antenna shows numerical high items. Under the certain motivating power, with the improvement of incentive frequency and antenna state gradually becomes stabilized, the dielectric tensor of each component distribution gradually becomes smooth and with no mutations items. So the dielectric tensor and its each component can be calculated through the model.

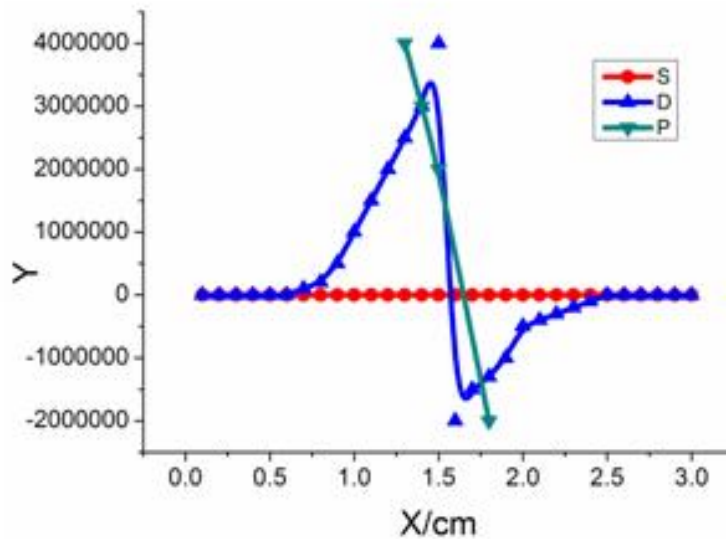

Fig. (6). The dielectric tensor when incentive power is 30W and frequency is 25MHz.

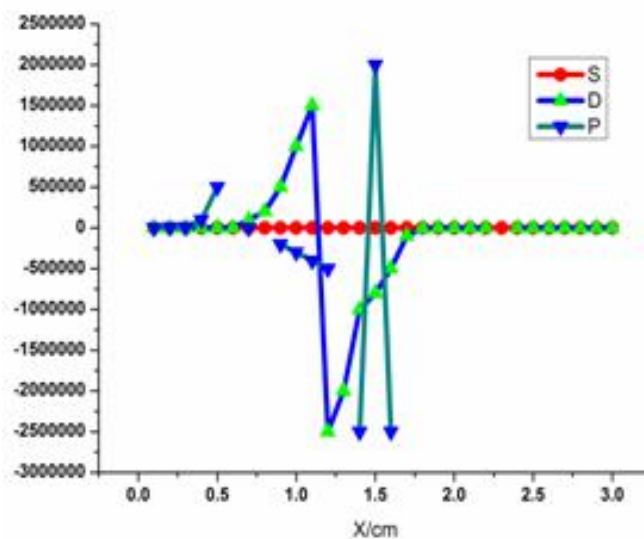

Fig. (7). The dielectric tensor when incentive power is 30W and frequency is 35MHz.

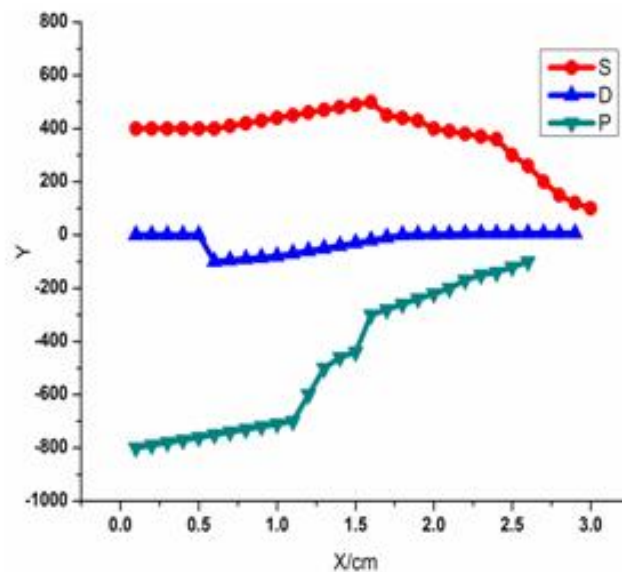

Fig. (8). The dielectric tensor when incentive power is 30W and frequency is 300MHz.

CONCLUSION

The calculation of plasma antenna dielectric constant, especially when there exists inductive magnetic field around the plasma antenna, is a complicated problem. Simulation based on XFDTD software cannot reflect the effect of antenna internal particle movement and external incentives to dielectric tensor, so the method based on software has many limitations and has low precision. Only through micro-level modeling analysis of particle movement, the higher approximate results can be obtained.

CONFLICT OF INTEREST

The author confirms that this article content has no conflict of interest.

ACKNOWLEDGEMENTS

Declared none.

REFERENCES

- [1] T. Anderson, *Plasma Antenna*. Artech House, 2011, pp. 79-112.
- [2] R. Kumar, and D. Bora, "A reconfigurable plasma antenna", *J. Appl. Phys.*, vol. 053303, pp. 1-5, 2010.
- [3] Y.A. Lanlan, T. Yan, and B. Wang, "Axisymmetric Surface-Wave Dispersion in Plasma Antenna", *Vacuum Sci. Tech.*, vol. 24, pp. 424-426, 2004.
- [4] G. Zhao, *Research of Basic Theory and Nonlinear Phenomena in Plasma Antennas*. Center for Space Science and Applied Research: Beijing, 2007, pp. 70-101.
- [5] Y.I. Burykin, S.M. Levitskiy, and V.G. Martynenko, "Establishing highly conductive path in gas by thermal guidance of discharge", *Radio Eng. Electron. Phys.*, vol. 20, pp. 86-88, 1975.
- [6] J.P. Rayner, A.P. Whichello, and A.D. Cheetham, "Physical characteristics of plasma antennas", *IEEE Trans. Plasma Sci.*, vol. 32, no. 1, pp. 269-281, 2004.
[<http://dx.doi.org/10.1109/TPS.2004.826019>]
- [7] G.G. Borg, J.H. Harris, N.M. Martin, D. Thorncraft, R. Milliken, D. G. Miljak, B. Kwan, T. Ng, and J. Kircher, "Plasmas as antennas: Theory, experiment and applications", *Phys. Plasmas*, vol. 7, no. 7, pp. 2198-2202, 2000.
[<http://dx.doi.org/10.1063/1.874041>]
- [8] Z. Dai, S. Liu, and Y. Chen, "Development and investigation of reconfigurable plasma antennas", In: *2010 International Conference on Microwave and Millimeter Wave Technology*. 2010, pp. 1135-1137.
[<http://dx.doi.org/10.1109/ICMMT.2010.5525072>]
- [9] Z. Liang, *Research on Electronical Function and Noise Mechanism of Plasma-column Antenna*. Center for Space Science and Applied Research: Beijing, 2008.

- [10] P. Russo, "G. Cerri E. Vecchioni. Self-consistent model for the characterization of plasma ignition by propagation of an electromagnetic wave to be used for plasma antennas design", *IET Microw. Antennas Propag.*, vol. 4, no. 12, pp. 2256-2264, 2010. [<http://dx.doi.org/10.1049/iet-map.2009.0290>]
- [11] "Self-consistent model for the characterisation of plasma ignition by propagation of an electromagnetic wave to be used for plasma antennas design", In: *European Conference on Antennas and Propagation*. 2010, pp. 12-16.

© Jin Hongying; Licensee *Bentham Open*.

This is an open access article licensed under the terms of the Creative Commons Attribution-Non-Commercial 4.0 International Public License (CC BY-NC 4.0) (<https://creativecommons.org/licenses/by-nc/4.0/legalcode>), which permits unrestricted, non-commercial use, distribution and reproduction in any medium, provided the work is properly cited.